

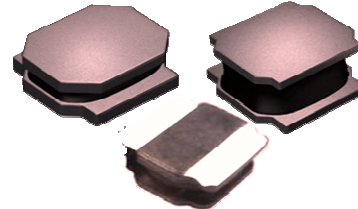

◆ **Features**

- 1、Magnetic-resin shielded construction reduces buzz noise to ultra-low levels;
- 2、Metallization on ferrite core results in excellent shock resistance and damage-free durability;
- 3、Closed magnetic circuit design reduces leakage
- 4、Small and low profile inductor;
- 5、Take up less PCB real estate and save more power。



◆ **Applications**

- 1、Smart phone;
- 2、Mobile devices with multifunction such as adding color TV and camera;
- 3、Flat-screen TVs, blue-ray disc recorders, set top boxes;
- 4、Notebooks, desktop computers, servers, graphic cards;
- 5、Portable gaming devices, personal navigation systems, personal multimedia devices;
- 6、Automotive systems;
- 7、Telecomm base stations.

◆ **Lead Free Part Numbering**

CMLW 201610 P 2R2 M S T
(1) (2) (3) (4) (5) (6) (7)

- (1) Series Type
- (2) Dimension : L×W×H(2.0×1.6×1.0mm)
- (3) Material Code
- (4) Inductance: 2R2=2.2μH ;
100=10μH; 101=100μH
- (5) Inductance Tolerance: M=±20%, N=±30%
- (6) Company Code
- (7) Packaging : Tape Carrier Package

◆ **Dimensions**

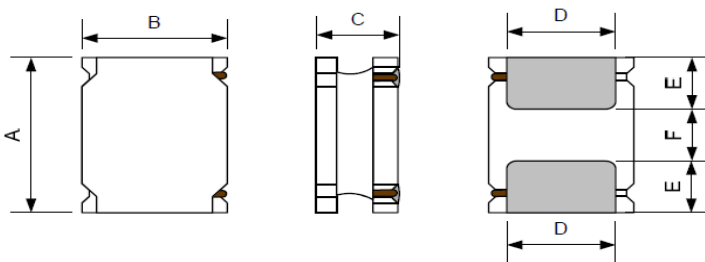

Recommended Land Pattern

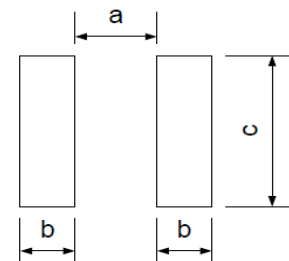

Unit:mm

Series	A	B	C	D	E	F	a Typ.	b Typ.	c Typ.
CMLW201610P	2.0±0.2	1.6±0.2	1.0Max.	1.2±0.2	0.60±0.2	0.80±0.2	0.70	0.70	1.7

◆ **Electrical Characteristics**

- 1) Operating temperature range (Including self-heating): -40°C ~ +125°C
- 2) Storage temperature range (packaging conditions): -10°C ~ +40°C and RH 70% (Max.)

◆ **Construction and material**



No.	Components	Material
①	Core	Soft magnetic Metal
②	Wire	Polyurethane system enameled copper wire
③	Magnetic Glue	Epoxy resin and magnetic powder
④	substrate	FeNiCu/Ag or Ag/Ni/Sn
⑤	Top Electrodes	Sn alloy
⑥	Marking	Nitrocellulose

◆ **REFLOW-PROFILE**

Limit Profile

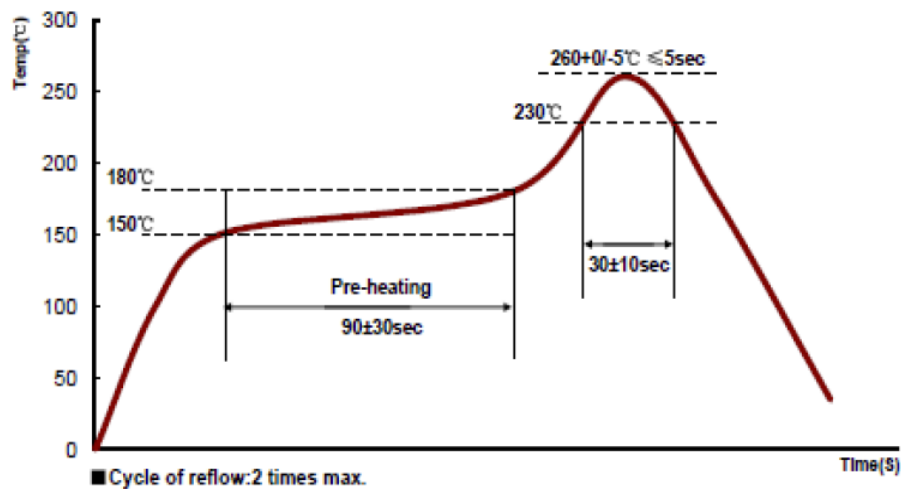

Standard Profile (for EOC Solder paste S70G-HF)

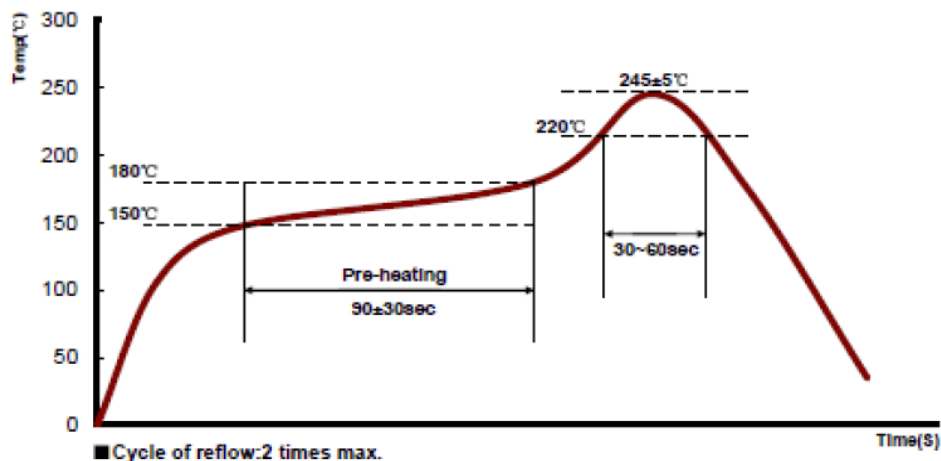

◆ **Specification**

Part Number	Inductance @1MHz,0.1V (μH)	DC Resistance($\text{m}\Omega$)		Saturation Current Isat		Heat Rating Current Irms	
		DCR		Min. (A)	Typ. (A)	Min. (A)	Typ. (A)
		Typ.	Max.				
CMLW201610P Series							
CMLW201610PR24MST	0.24 \pm 20%	33.0	40.0	4.50	5.50	3.00	3.45
CMLW201610PR47MST	0.47 \pm 20%	41.0	49.0	4.00	4.70	2.70	3.10
CMLW201610PR68MST	0.68 \pm 20%	57.0	65.0	3.50	4.00	2.50	2.80
CMLW201610P1R0MST	1.0 \pm 20%	75.0	90.0	2.60	2.80	2.05	2.35
CMLW201610P1R5MST	1.5 \pm 20%	110	130	1.95	2.30	1.70	2.00
CMLW201610P2R2MST	2.2 \pm 20%	142	170	1.90	2.15	1.45	1.70
CMLW201610P4R7MST	4.7 \pm 20%	370	425	1.20	1.50	0.90	1.00
CMLW201610P6R8MST	6.8 \pm 20%	500	600	1.10	1.40	0.70	0.80
CMLW201610P100MST	10 \pm 20%	688	826	0.80	0.95	0.65	0.75

◆ **Note**

- 1: All test data is referenced to 20°C ambient;
- 2: Rated current: Isat or Irms, whichever is smaller;
- 3: Isat: DC current at which the inductance drops approximate 30% from its value without current;
- 4: Irms: DC current that causes the temperature rise ($\Delta T = 40^\circ\text{C}$) from 20°C ambient.

◆ **TYPICAL ELECTRICAL CHARACTERISTICS**

CMLW201610P Series

Temperature vs.DC Current Characteristics

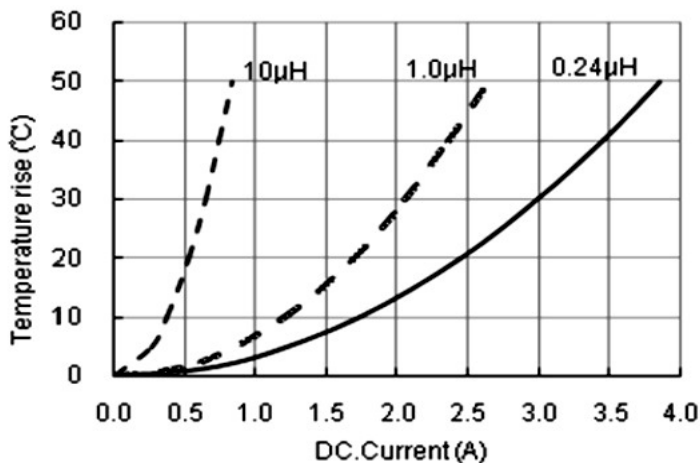

Inductance vs.DC Current Characteristics

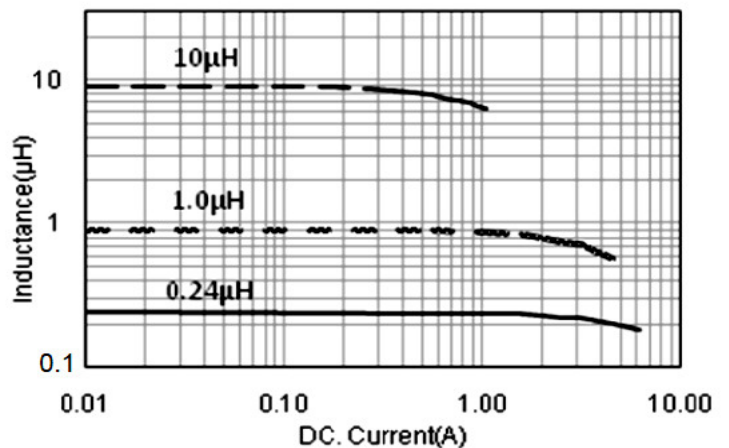

◆ Reliability Test

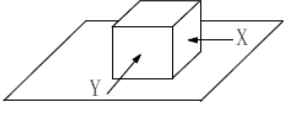
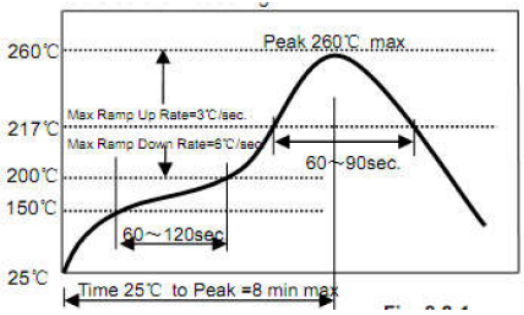
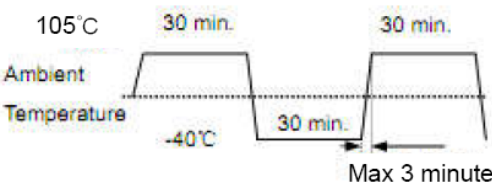
Items	Requirements	Test Methods and Remarks
A. Terminal Strength	No removal or split of the termination or other defects shall occur.  Fig.7.1-1	1) Solder the inductor to the testing jig (glass epoxy board shown in Fig.7.1-1) using eutectic solder. Then apply a force in the direction of the arrow. 2) 10N force. 3) Keep time: 5±2s
B. High Temperature	1. No visible mechanical damage. 2. Inductance change: Within ±10%	1) Storage Temperature :125+/-5°C 2) Duration : 96 ±4 Hours 3) Recovery : then measured at room ambient temperature after placing 24 hours.
C. Low Temperature	1. No visible mechanical damage 2. Inductance change: Within ±10%	1) Temperature and time: -40±5°C 2) Duration: 96±4 hours 3) TRecovery : then measured at room ambient temperature after placing 24 hours.
D. Vibration test	1. No visible mechanical damage. 2. Inductance change: Within ±10%	1) Frequency range:10HZ~55HZ~10HZ 2) Amplitude:1.5mm p-p 3) Direction:X,Y,Z 4) Time:1 minute/cycle,2hours per axis
E. High Temperature Storage Tested	1. No visible mechanical damage. 2. Inductance change: Within ±10%	1) Storage Temperature :60+/-2°C 2) Relative Humidity :90-95% RH 3) Duration : 96 ±4 Hours 4) Recovery : then measured at room ambient temperature after placing 24 hours.
F. Resistance to Soldering Heat	1. No visible mechanical damage. 2. Inductance change: Within ±10%  Fig. 1	1) Re-flowing Profile: Please refer to Fig. 1 2) Test board thickness: 1.0mm 3) Test board material: glass epoxy resin 4) The chip shall be stabilized at normal condition for 1~2 hours before measuring
G. Thermal Shock	1. No visible mechanical damage. 2. Inductance change: Within ±10%  Fig. 2	1) Temperature and time: -40±3°C for 30±3 min→105°C for 30±3min, please refer to Fig. 2. 2) Transforming interval: Max, 3 minute 3) Tested cycle: 100 cycles 4) The chip shall be stabilized at normal condition for 1~2 hours before measuring

◆Packaging and Marking:

1. Carrier Tape Dimensions:

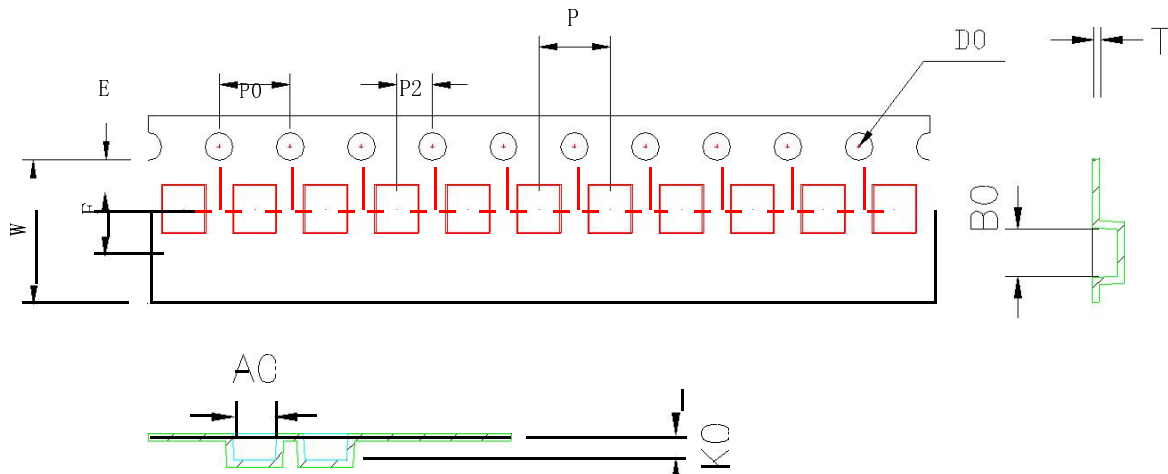

ITEM	W	A0	B0	K0	P	F	E	D0	P0	P2	T
DIM	8.00	2.00	2.40	1.20	4.00	3.5	1.75	1.50	4.00	2.00	0.25
TOLE	±0.3	±0.1	±0.1	±0.1	±0.1	±0.1	±0.1	+0.1	±0.1	±0.1	±0.05

2. Taping Dimensions:

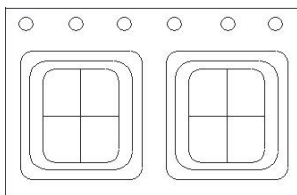

3. Reel Dimensions:

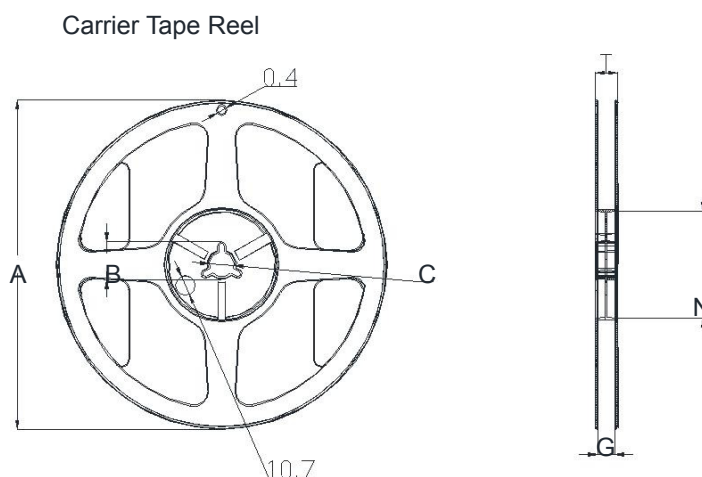

Type	A	B	C	G	N	T
8mm	178	20.7±0.8	13±0.4	9	60	10.8

4. Packaging Quantity:

Standard Packing Quantity: 2000 pcs/reel