

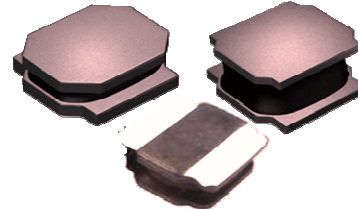

◆ **Features**

- 1、Magnetic-resin shielded construction reduces buzz noise to ultra-low levels;
- 2、Metallization on ferrite core results in excellent shock resistance and damage-free durability;
- 3、Closed magnetic circuit design reduces leakage
- 4、Small and low profile inductor;
- 5、Take up less PCB real estate and save more power。



◆ **Applications**

- 1、Smart phone;
- 2、Mobile devices with multifunction such as adding color TV and camera;
- 3、Flat-screen TVs, blue-ray disc recorders, set top boxes;
- 4、Notebooks, desktop computers, servers, graphic cards;
- 5、Portable gaming devices, personal navigation systems, personal multimedia devices;
- 6、Automotive systems;
- 7、Telecomm base stations。

◆ **Lead Free Part Numbering**

CMLW 3012 P 2R2 M S T
(1) (2) (3) (4) (5) (6) (7)

- (1) Series Type
- (2) Dimension : L×W×H(3.0×3.0×1.2mm)
- (3) Material Code
- (4) Inductance: R47=0.47μH ;
2R2=2.2μH; 100=10μH
- (5) Inductance Tolerance: M=±20%, N=±30%
- (6) Company Code
- (7) Packaging : Tape Carrier Package

◆ **Dimensions**

Recommended Land Pattern

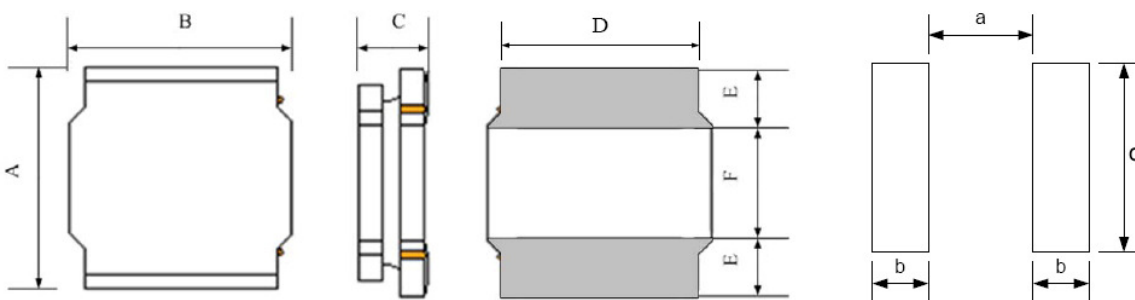

Unit:mm

Series	A	B	C	D	E	F	a Typ.	b Typ.	c Typ.
CMLW3012P	3.0±0.2	3.0±0.2	1.2Max.	2.6±0.2	0.75±0.2	1.5±0.2	1.5	0.8	3.2

◆ **Electrical Characteristics**

- 1) Operating temperature range (Including self-heating): -40°C ~ +125°C
- 2) Storage temperature range (packaging conditions): -10°C ~ +40°C and RH 70% (Max.)

◆ **Construction and material**



No.	Components	Material
①	Core	Soft magnetic Metal
②	Wire	Polyurethane system enameled copper wire
③	Magnetic Glue	Epoxy resin and magnetic powder
④	substrate	FeNiCu/Ag or Ag/Ni/Sn
⑤	Top Electrodes	Sn alloy
⑥	Marking	Nitrocellulose

◆ **REFLOW-PROFILE**

Limit Profile

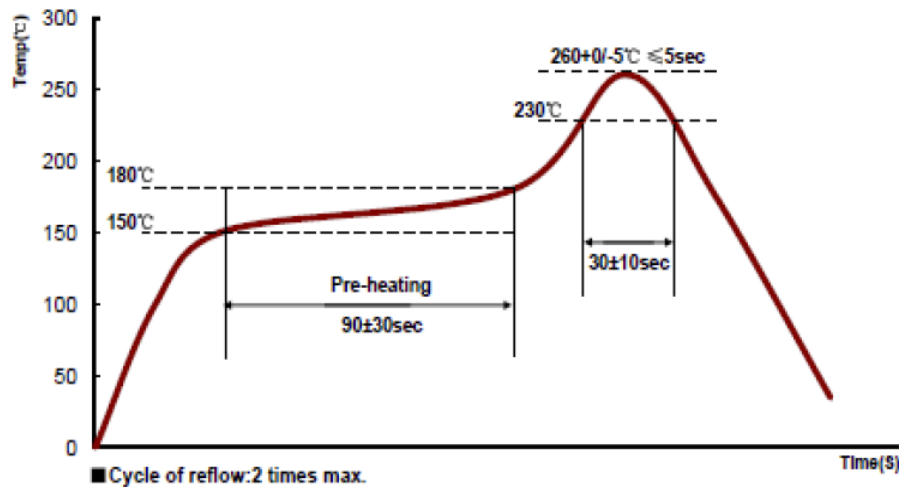

Standard Profile (for EOC Solder paste S70G-HF)



◆ **Specification**

Part Number	Inductance @1MKHz,0.1V (μH)	DC Resistance($\text{m}\Omega$)		Saturation Current Isat		Heat Rating Current Irms	
		DCR		Max. (A)	Typ. (A)	Max. (A)	Typ. (A)
		Typ.	Max.				
CMLW3012P Series							
CMLW3012PR22MST	0.22 \pm 20%	20	26	10.0	9.30	4.80	4.20
CMLW3012PR33MST	0.33 \pm 20%	23	27	8.90	7.20	4.80	4.10
CMLW3012PR47MST	0.47 \pm 20%	28	33	8.00	6.80	4.50	3.90
CMLW3012PR68MST	0.68 \pm 20%	35	42	6.80	5.80	3.90	3.40
CMLW3012P1R0MST	1.0 \pm 20%	45	54	5.40	4.20	3.10	2.70
CMLW3012P1R5MST	1.5 \pm 20%	64	74	4.10	3.40	2.90	2.50
CMLW3012P2R2MST	2.2 \pm 20%	90	108	3.35	2.80	3.25	2.05
CMLW3012P3R3MST	3.3 \pm 20%	129	155	2.60	2.20	2.00	1.70
CMLW3012P4R7MST	4.7 \pm 20%	196	235	2.50	2.00	1.50	1.30
CMLW3012P6R8MST	6.8 \pm 20%	290	340	1.20	1.45	1.10	1.25
CMLW3012P100MST	10.0 \pm 20%	395	474	1.45	1.20	1.15	1.00

◆ **Note**

- 1: All test data is referenced to 20°C ambient;
- 2: Rated current: Isat or Irms, whichever is smaller;
- 3: Isat: DC current at which the inductance drops approximate 30% from its value without current;
- 4: Irms: DC current that causes the temperature rise ($\Delta T = 40^\circ\text{C}$) from 20°C ambient.

◆ **TYPICAL ELECTRICAL CHARACTERISTICS**

Temperature vs. DC Current Characteristics

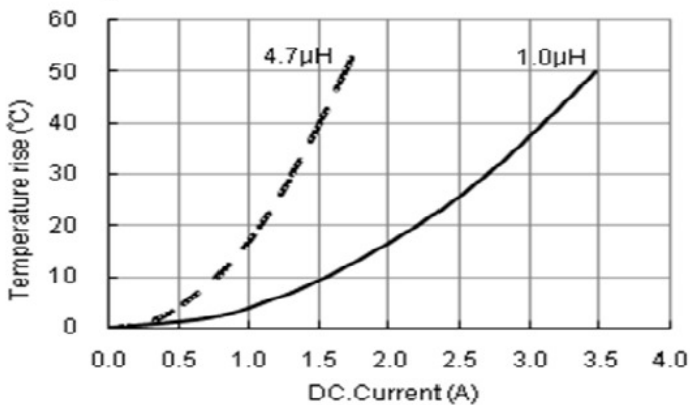

Inductance vs. DC Current Characteristics

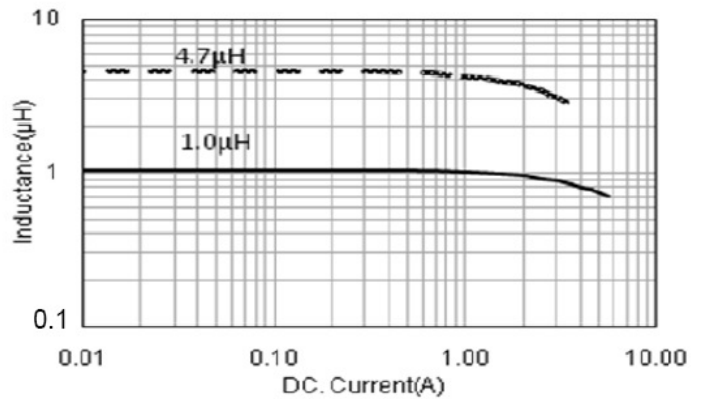

◆ Reliability Test

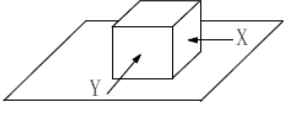
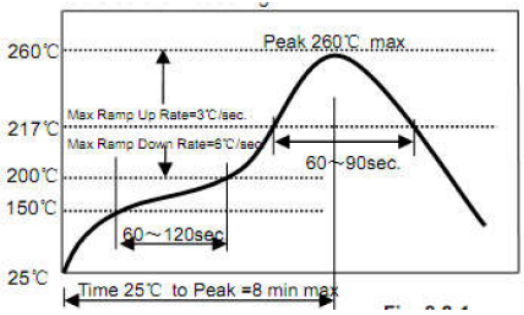
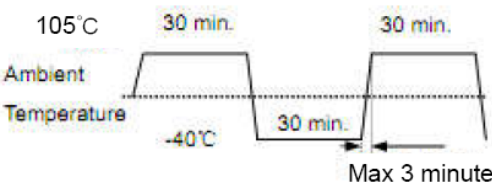
Items	Requirements	Test Methods and Remarks
A. Terminal Strength	No removal or split of the termination or other defects shall occur.  Fig.7.1-1	1) Solder the inductor to the testing jig (glass epoxy board shown in Fig.7.1-1) using eutectic solder. Then apply a force in the direction of the arrow. 2) 10N force. 3) Keep time: 5±2s
B. High Temperature	1. No visible mechanical damage. 2. Inductance change: Within ±10%	1) Storage Temperature :125+/-5°C 2) Duration : 96 ±4 Hours 3) Recovery : then measured at room ambient temperature after placing 24 hours.
C. Low Temperature	1. No visible mechanical damage 2. Inductance change: Within ±10%	1) Temperature and time: -40±5°C 2) Duration: 96±4 hours 3) TRecovery : then measured at room ambient temperature after placing 24 hours.
D. Vibration test	1. No visible mechanical damage. 2. Inductance change: Within ±10%	1) Frequency range:10HZ~55HZ~10HZ 2) Amplitude:1.5mm p-p 3) Direction:X,Y,Z 4) Time:1 minute/cycle,2hours per axis
E. High Temperature Storage Tested	1. No visible mechanical damage. 2. Inductance change: Within ±10%	1) Storage Temperature :60+/-2°C 2) Relative Humidity :90-95% RH 3) Duration : 96 ±4 Hours 4) Recovery : then measured at room ambient temperature after placing 24 hours.
F. Resistance to Soldering Heat	1. No visible mechanical damage. 2. Inductance change: Within ±10%  Fig. 1	1) Re-flowing Profile: Please refer to Fig. 1 2) Test board thickness: 1.0mm 3) Test board material: glass epoxy resin 4) The chip shall be stabilized at normal condition for 1~2 hours before measuring
G. Thermal Shock	1. No visible mechanical damage. 2. Inductance change: Within ±10%  Fig. 2	1) Temperature and time: -40±3°C for 30±3 min→105°C for 30±3min, please refer to Fig. 2. 2) Transforming interval: Max, 3 minute 3) Tested cycle: 100 cycles 4) The chip shall be stabilized at normal condition for 1~2 hours before measuring

◆Packaging and Marking:

1. Carrier Tape Dimensions:

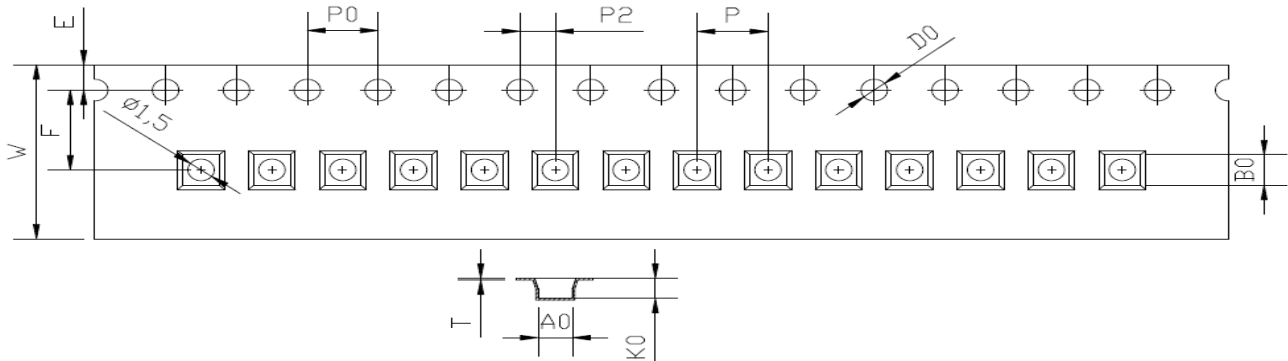

ITEM	W	A0	B0	K0	P	F	E	D0	P0	P2	T
DIM	8.00	3.3	3.3	1.6	4.00	3.50	1.75	1.50	4.00	2.00	0.25
TOLE	±0.1	±0.05	±0.05	±0.1	±0.1	±0.1	±0.1	+0.1	±0.1	±0.1	±0.05

2. Taping Dimensions:

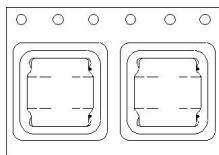

3. Reel Dimensions:

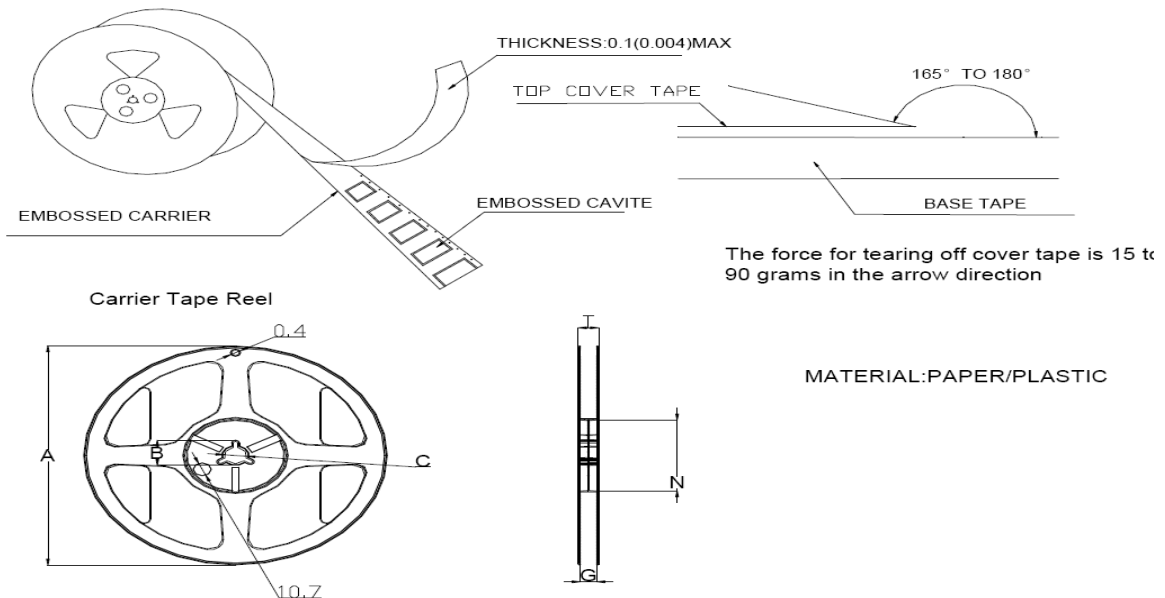

Type	A	B	C	G	N	T
8mm	178	20.7±0.8	13±0.4	9	60	10.8

4. Packaging Quantity:

Standard Packing Quantity: 2000 pcs/reel